



artelite

MODERNO

Descriptions et finis - <i>Specifications and finishes</i>	4
Bureaux - <i>Desks</i>	6
Retours et surfaces de jonction - <i>Returns and bridge connectors</i>	7
Bahuts - <i>Credenzas</i>	8
Modules de rangement - <i>Storage units</i>	10
Tables - <i>Tables</i>	17
Unité tableau-marqueur - <i>Markerboard unit</i>	18
Accessoires - <i>Accessories</i>	19
Conditions de vente - <i>Conditions of sale</i>	22
Informations générales - <i>General informations</i>	22

Caractéristiques

Les surfaces de travail de la série Moderno, d'une épaisseur de 1 1/2", sont en placage de bois naturel appareillé et sont munies d'un chant droit.

Les piétements des bureaux ont un ton différent de la surface. Le panneau de modestie des bureaux est en retrait de 8". Les tables de travail sont munies d'un tiroir central.

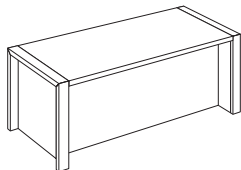

Les meubles sont tous équipés de niveleurs.

Caissons

Les bureaux, les retours et les bahuts sont disponibles avec les caissons au sol (**A** et **B**).

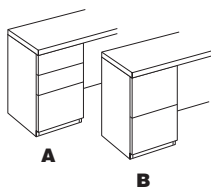

Tous les caissons sont munis de serrures en équipements standard. Les devants de tiroirs sont munis de poignées intégrées.

Bahuts

Les bahuts sont assemblés mais des configurations particulières peuvent être créées à partir d'un choix de composantes modulaires.

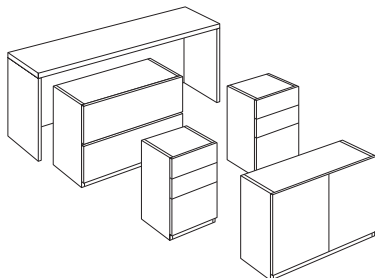

Armoires

Les armoires, bibliothèques et penderies sont offertes en plusieurs configurations. Les tablettes des armoires et des bibliothèques sont réglables.

Finis - 2 tons standard

La présente liste de prix indique des prix correspondants aux bois du grade 1. Pour un grade optionnel, ajoutez au prix de liste le pourcentage d'augmentation indiqué au grade désiré :

Grade 1 (prix de liste)

ESSENCES DE BOIS

Noyer
Acajou
Cerisier
Érable
Chêne

Prix de liste

Grade 2 (ajouter 10% au prix de liste)

ESSENCES DE BOIS

% EN PLUS

Anigre
Érable ondulé
Pomelle
Bubinga

+ 10%

Tous les panneaux verticaux sont plaqués horizontalement.

Consultez les cartes d'échantillons des finis de bois afin d'obtenir le code des finis disponibles et ajoutez ce code à la suite du code du meuble désiré.

Note

Toutes les dimensions indiquées sont nominales.

Bordure standard - chant droit

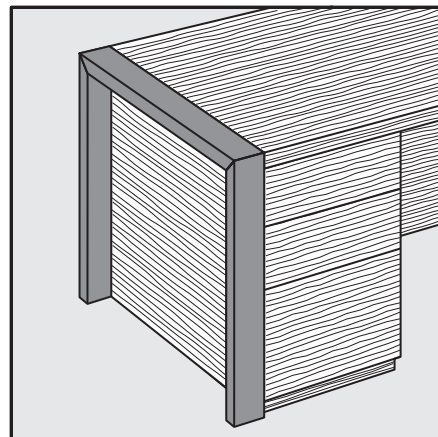

Spécifications

The *Moderno Collection* is made with matched natural wood veneers. The 1 1/2" thick work surfaces are equipped with straight edges.

The desk legs are finished in a different color than the surface. The straight front modesty panels are recessed 8". The work tables are equipped with one center drawer.

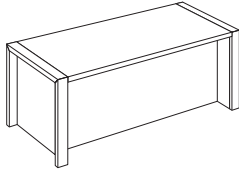

All casegood are equipped with levellers.

Pedestals

Desks, returns and credenzas are available with low pedestals (**A** and **B**).

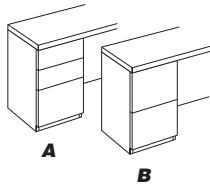

Locks are standard equipment on all pedestals. Drawer fronts are equipped with integrated handle.

Credenzas

The credenzas are assembled but particular configurations can be created from a choice of modular options.

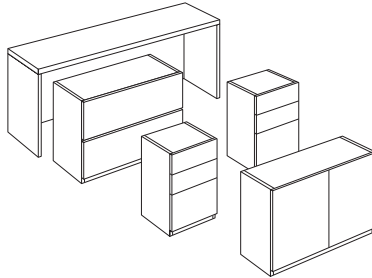

Cabinets

Many configurations of cabinets, bookcases, wardrobes are available. All cabinets and bookcases have adjustable shelves.

Choice of edges - 2 tones standard

The price list shows Grade 1 prices. Optional veneers are subject to upcharge. Apply indicated upcharge to desired veneer.

Grade 1 (list price)

WOOD SPECIES

- Walnut
- Mahogany
- Cherry
- Maple
- Oak

List price

Grade 2 (add 10% to list price)

WOOD SPECIES

% TO ADD

- Anigre
- Curly maple
- Pomelly
- Bubinga

+ 10%

All vertical panels are veneered horizontally.

Consult the sample cards in your catalogue to specify the available finish code and add this code immediately after the furniture code.

Note

All indicated dimensions are approximate.

Standard edging - Straight edge

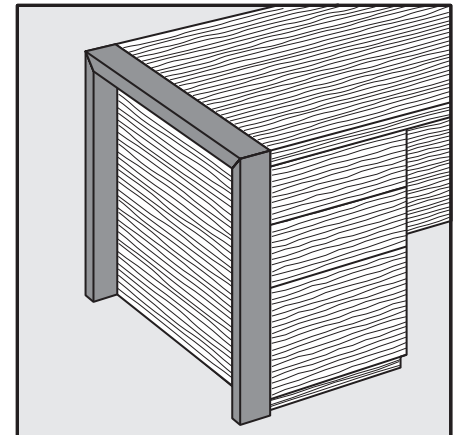

Les caissons des bureaux sont munis d'une serrure.

Desk pedestals are equipped with a lock.

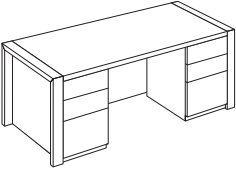
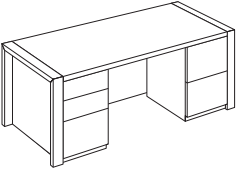
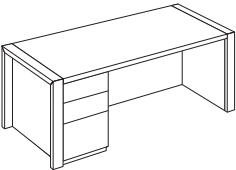
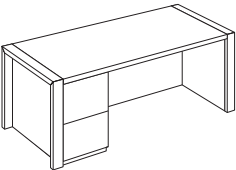
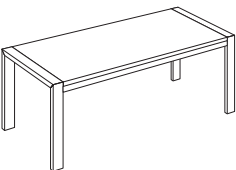
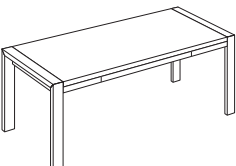
MODÈLE MODEL	DESCRIPTION DESCRIPTION	LARG. WIDTH	PROF. DEPTH	HAUT. HEIGHT	POIDS WEIGHT lbs -lbs	VOLUME VOLUME p ³ -ft ³	CODE CODE	PRIX PRICE	
	Bureau directeur avec 2 caissons tout usage.	84"	36"	29"	470	59	MO/A-8436-A	5440	
		78"	36"	29"	450	55	MO/A-7836-A	5290	
	<i>Executive desk with 2 utility pedestals.</i>	72"	36"	29"	430	51	MO/A-7236-A	5160	
		84"	30"	29"	400	50	MO/A-8430-A	5180	
		78"	30"	29"	380	46	MO/A-7830-A	5020	
		72"	30"	29"	365	42	MO/A-7230-A	4900	
	Bureau directeur avec caisson tout usage à gauche et caisson filière à droite.	84"	36"	29"	470	59	MO/A-8436-B	5440	
		78"	36"	29"	450	55	MO/A-7836-B	5290	
	<i>Executive desk with utility pedestal on left and filing pedestal on right.</i>	72"	36"	29"	430	51	MO/A-7236-B	5160	
		84"	30"	29"	400	50	MO/A-8430-B	5180	
		78"	30"	29"	380	46	MO/A-7830-B	5020	
		72"	30"	29"	365	42	MO/A-7230-B	4900	
	Bureau directeur avec caisson tout usage à gauche.	84"	36"	29"	400	59	MO/A-8436	4390	
		78"	36"	29"	380	55	MO/A-7836	4240	
	<i>Executive desk with utility pedestal on left. For pedestal on right (MO/7836-A)</i>	Pour caisson à droite (MO/7836-A)	72"	36"	29"	360	51	MO/A-7236	4110
		84"	30"	29"	330	50	MO/A-8430	4130	
		78"	30"	29"	310	46	MO/A-7830	3980	
		72"	30"	29"	295	42	MO/A-7230	3860	
	Bureau directeur avec caisson filière à gauche.	84"	36"	29"	400	59	MO/B-8436	4390	
		78"	36"	29"	380	55	MO/B-7836	4240	
	<i>Executive desk with filing pedestal on left. For pedestal on right (MO/7836-B)</i>	Pour caisson à droite (MO/7836-B)	72"	36"	29"	360	51	MO/B-7236	4110
		84"	30"	29"	330	50	MO/B-8430	4130	
		78"	30"	29"	310	46	MO/B-7830	3980	
		72"	30"	29"	295	42	MO/B-7230	3860	
	Table de travail.	78"	36"	29"	310	55	MO/T-7836	3020	
		72"	36"	29"	290	51	MO/T-7236	2750	
		78"	30"	29"	290	46	MO/T-7830	2860	
		72"	30"	29"	270	42	MO/T-7230	2600	
	Table de travail avec tiroir central.	78"	36"	29"	320	55	MO/TD-7836	3420	
		72"	36"	29"	300	51	MO/TD-7236	3150	
		78"	30"	29"	300	46	MO/TD-7830	3260	
		72"	30"	29"	280	42	MO/TD-7230	3000	
	<i>Table desk with center drawer.</i>								

Les retours et les surfaces de jonction sont livrés avec la quincaillerie de fixation nécessaire.

The returns and bridge connectors are delivered with the necessary fastening hardware.

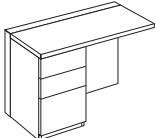
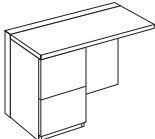
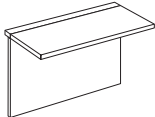
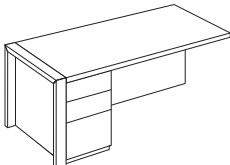
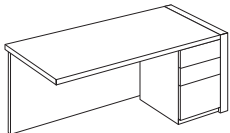
MODÈLE MODEL	DESCRIPTION DESCRIPTION	LARG. WIDTH	PROF. DEPTH	HAUT. HEIGHT	POIDS WEIGHT lbs -lbs	VOLUME VOLUME p ³ -ft ³	CODE CODE	PRIX PRICE
	Retour directeur gauche avec caisson tout usage.	60"	23"	29"	230	28	MO/ERL-A-6023	2680
	Pour retour droit	48"	23"	29"	200	23	MO/ERL-A-4823	2550
	(MO/ ERR-6023-A)	42"	23"	29"	180	20	MO/ERL-A-4223	2480
	<i>Left executive return with utility pedestal. For right return (MO/ERR-6023-A)</i>							
	Retour directeur gauche avec caisson filière.	60"	23"	29"	230	28	MO/ERL-B-6023	2680
	Pour retour droit	48"	23"	29"	200	23	MO/ERL-B-4823	2550
	(MO/ ERR-6023-B)	42"	23"	29"	180	20	MO/ERL-B-4223	2480
	<i>Left executive return with filing pedestal. For right return (MO/ERR-6023-B)</i>							
	Surface de jonction directeur.	60"	23"	29"	130	5	MO/JTE-6023	1410
		48"	23"	29"	110	4	MO/JTE-4823	1280
		42"	23"	29"	90	3	MO/JTE-4223	1210
	<i>Executive bridge connector.</i>							
	Bureau avec caisson tout usage à gauche pour installation à droite.	72"	36"	29"	235	51	MO/UA-7236	3490
	<i>Desk with utility pedestal on left for right installation.</i>							
	Bureau avec caisson tout usage à droite pour installation à gauche.	72"	36"	29"	235	51	MO/7236-AU	3490
	<i>Desk with utility pedestal on right for left installation.</i>							

Les caissons, les classeurs latéraux et les armoires sont munis d'une serrure.

All pedestals, lateral files and cabinets are equipped with a lock.

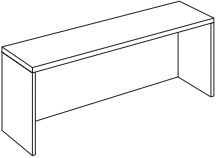
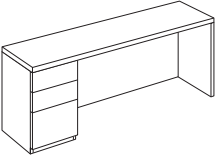
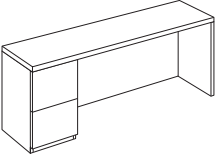
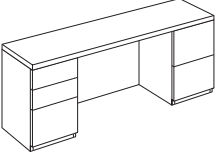
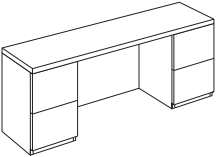
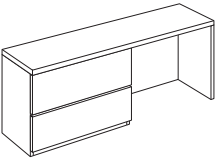
MODÈLE MODEL	DESCRIPTION DESCRIPTION	LARG. WIDTH	PROF. DEPTH	HAUT. HEIGHT	POIDS WEIGHT lbs - lbs	VOLUME VOLUME p ³ -ft ³	CODE CODE	PRIX PRICE
	Bahut ouvert.	78"	20"	29"	175	35	MO/7820	1650
		72"	20"	29"	165	30	MO/7220	1510
		60"	20"	29"	140	25	MO/6020	1370
	<i>Credenza shell.</i>							
	Bahut avec	78"	20"	29"	225	35	MO/A-7820	3050
	1 caisson tout usage à gauche.	72"	20"	29"	215	30	MO/A-7220	2920
	Pour caisson à droite (MO/7820- A)	60"	20"	29"	190	25	MO/A-6020	2790
	<i>Credenza with 1 utility pedestal on left. For right pedestal (MO/7820-A)</i>							
	Bahut avec	78"	20"	29"	225	35	MO/B-7820	3050
	1 caisson filière à gauche.	72"	20"	29"	215	30	MO/B-7220	2920
	Pour caisson à droite (MO/7820- B)	60"	20"	29"	190	25	MO/B-6020	2790
	<i>Credenza with 1 filing pedestal on left. For right pedestal (MO/7820-B)</i>							
	Bahut avec	78"	20"	29"	265	35	MO/A-7820-B	4200
	caisson tout usage à gauche et caisson filière à droite.	72"	20"	29"	255	30	MO/A-7220-B	4060
		60"	20"	29"	230	25	MO/A-6020-B	3920
	<i>Credenza with utility pedestal on left and filing pedestal on right.</i>							
	Bahut avec	78"	20"	29"	265	35	MO/B-7820-B	4200
	2 caissons filière.	72"	20"	29"	255	30	MO/B-7220-B	4060
		60"	20"	29"	230	25	MO/B-6020-B	3920
	<i>Credenza with 2 filing pedestals.</i>							
	Bahut avec	72"	20"	29"	270	30	MO/FL-7220	3470
	1 classeur latéral à gauche.	60"	20"	29"	250	25	MO/F-6020	3260
	Pour classeur à droite (MO/7820- FL)							
	<i>Credenza with 1 lateral file on left. For right file (MO/7820-FL)</i>							

Les caissons, les classeurs latéraux et les armoires sont munis d'une serrure.

All pedestals, lateral files and cabinets are equipped with a lock.

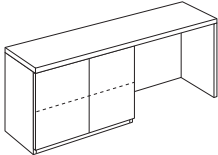
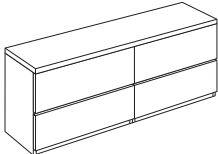
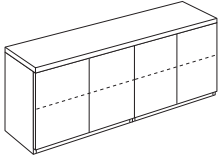
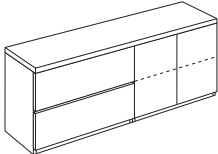
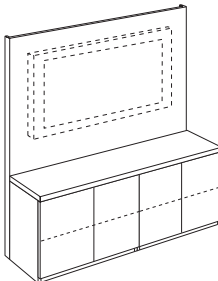
MODÈLE MODEL	DESCRIPTION DESCRIPTION	LARG. WIDTH	PROF. DEPTH	HAUT. HEIGHT	POIDS WEIGHT lbs -lbs	VOLUME VOLUME p ³ -ft ³	CODE CODE	PRIX PRICE
	Bahut avec 1 armoire à gauche. Pour armoire à droite (MO/7820- HL)	72" 60"	20" 20"	29" 29"	215 190	30 25	MO/HL-7220 MO/H-6020	2890 2680
	<i>Credenza with 1 storage cabinet on left. For right cabinet (MO/7820-HL)</i>							
	Bahut avec 2 classeurs latéraux.	72" 60"	20" 20"	29" 29"	280 255	30 25	MO/FL-7220-FL MO/F-6020-F	4390 4180
	<i>Credenza with 2 lateral files.</i>							
	Bahut avec 2 armoires.	72" 60"	20" 20"	29" 29"	230 210	30 25	MO/HL-7220-HL MO/H-6020-H	3570 3360
	<i>Credenza with 2 storage cabinets.</i>							
	Bahut avec 1 classeur latéral et 1 armoire.	72" 60"	20" 20"	29" 29"	255 230	30 25	MO/FL-7220-HL MO/F-6020-H	3980 3770
	<i>Credenza with 1 lateral file and 1 storage cabinet.</i>							
	Bahut avec 2 armoires et panneau mural pour écran plat.	72" 60"	23" 23"	78" 78"	430 410		MO/HL-7222-HL-TV MO/H-6022-H-TV	5500 5225
	<i>Credenza with 2 storage cabinets and wall panel for flat screen.</i>							

Les caissons sont munis d'une serrure. Les modules de rangement sans dessus sont utilisés pour composer les bahuts. Les dessus sont disponibles au pied linéaire (voir page 12).

All pedestals are equipped with a lock. The storage units without top are used to build credenzas. Tops are available per linear foot (see page 12).

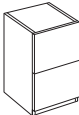
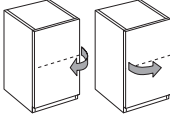
MODÈLE MODEL	DESCRIPTION DESCRIPTION	LARG. WIDTH	PROF. DEPTH	HAUT. HEIGHT	POIDS WEIGHT lbs -lbs	VOLUME VOLUME p ³ -ft ³	CODE CODE	PRIX PRICE
	Caisson tout usage sans dessus. <i>Utility pedestal without top.</i>	15 1/2"	20"	27 1/2"	45	7	MO/A-20	1410
	Caisson filière sans dessus. <i>Filing pedestal without top.</i>	15 1/2"	20"	27 1/2"	45	7	MO/B-20	1410
	Caisson gauche avec porte sans dessus. 1 tablette réglable. Pour caisson droit (MO/ HSR-20) <i>Left closed pedestal without top. 1 adjustable shelf. For right pedestal (MO/HSR-20)</i>	15 1/2"	20"	27 1/2"	35	7	MO/HSL-20	960
	Classeur latéral sans dessus. <i>Lateral file without top.</i>	30" 36"	20" 20"	27 1/2" 27 1/2"	110 120	12 14	MO/F-20 MO/FL-20	1640 1730
	Armoire fermée sans dessus. 1 tablette réglable. <i>Closed bookcase without top. 1 adjustable shelf.</i>	30" 36"	20" 20"	27 1/2" 27 1/2"	95 105	12 14	MO/H-20 MO/HL-20	1310 1370
	Armoire ouverte sans dessus. 1 tablette réglable. <i>Open bookcase without top. 1 adjustable shelf.</i>	30" 36"	20" 20"	27 1/2" 27 1/2"	90 95	12 14	MO/O-20 MO/OL-20	1100 1170

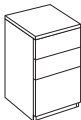
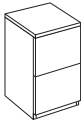
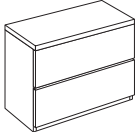
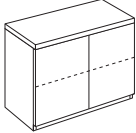
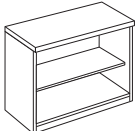

Les caissons, classeurs latéraux et les armoires sont munis d'une serrure.

All pedestals, lateral files and cabinets are equipped with a lock.

MODÈLE MODEL	DESCRIPTION DESCRIPTION	LARG. WIDTH	PROF. DEPTH	HAUT. HEIGHT	POIDS WEIGHT lbs -lbs	VOLUME VOLUME p ³ -ft ³	CODE CODE	PRIX PRICE
	Caisson tout usage autoportant avec dessus 3/4". <i>Freestanding utility pedestal with 3/4" top.</i>	15 1/2"	20"	27 1/2"	50	7	MO/AT-20	1650
	-R Option roulettes -R Option casters	Ajoutez 120 \$ Add 120 \$						
	Caisson filière autoportant avec dessus 3/4". <i>Freestanding filing pedestal with 3/4" top.</i>	15 1/2"	20"	27 1/2"	50	7	MO/BT-20	1650
	-R Option roulettes -R Option casters	Ajoutez 120 \$ Add 120 \$						
	Classeur latéral autoportant. Dessus inclus. <i>Freestanding lateral file. Top included.</i>	30" 36"	20" 20"	29" 29"	110 120	13 15	MO/FT-20 MO/FLT-20	2015 2190
	Armoire autoportante. 1 tablette réglable. Dessus inclus. <i>Closed freestanding bookcase. 1 adjustable shelf. Top included.</i>	30" 36"	20" 20"	29" 29"	95 105	13 15	MO/HT-20 MO/HLT-20	1710 1780
	Armoire ouverte autoportante. 1 tablette réglable. Dessus inclus. <i>Open freestanding bookcase. 1 adjustable shelf. Top included.</i>	30" 36"	20" 20"	29" 29"	90 95	13 15	MO/OT-20 MO/OLT-20	1510 1580

Les caissons, classeurs latéraux et les armoires sont munis d'une serrure.

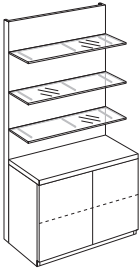
All pedestals, lateral files and cabinets are equipped with a lock.

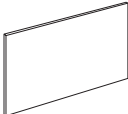
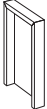
MODÈLE MODEL	DESCRIPTION DESCRIPTION	LARG. WIDTH	PROF. DEPTH	HAUT. HEIGHT	POIDS WEIGHT lbs -lbs	VOLUME VOLUME p ³ -ft ³	CODE CODE	PRIX PRICE	
	Armoire fermée autoportante avec panneau mural. 3 tablettes en verre. Dessus inclus.	30" 36"	20" 20"	78" 78"	245 255		MO/HT-3078-GL MO/HLT-3678-GL	3670 3860	
	<i>Closed freestanding bookcase with wall panel. 3 glass shelves. Top included.</i>								
	Dessus pour modules de rangement. Prix au pied linéaire.	XX XX	15" 20"				MO/TOP-__ 15 MO/TOP-__ 20	130 150	
	<i>Top for storage units. Price per linear foot.</i>								
	Panneau de modestie pour modules de rangement.	78" 72" 60" 42" 36" 30"		27" 27" 27" 27" 27" 27"			MO/MP-78 MO/MP-72 MO/MP-60 MO/MP-42 MO/MP-36 MO/MP-30	750 690 550 415 380 320	
	<i>Modesty panel for storage units.</i>								
		Piètement de bout.	20"	3"	29"			MO/END-U20	620
		<i>End panel.</i>							

Les huches peuvent être munies d'une serrure en option. Les dessus sont disponibles au pied linéaire (voir page 12). Les huches murales sont munies d'attaches murales. Avant l'installation, vérifier le type de structure murale.

An optional lock is available for the overhead cabinets. Tops are available per linear foot (see page 12). Wall mounted overhead cabinets are equipped with wall attachments. Before installation, please verify the wall structure.

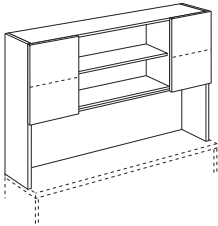
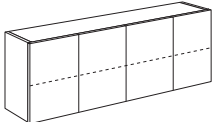
MODÈLE MODEL	DESCRIPTION DESCRIPTION	LARG. WIDTH	PROF. DEPTH	HAUT. HEIGHT	POIDS WEIGHT lbs - lbs	VOLUME VOLUME p ³ -ft ³	PORTES DOORS	CODE CODE	PRIX PRICE
	<i>Overhead cabinet with hinged doors.</i>	78"	15"	49"	190	43	4	MO/OCH-4978	2810
		72"	15"	49"	175	40	4	MO/OCH-4972	2610
		60"	15"	49"	150	33	4	MO/OCH-4960	2330
		48"	15"	49"	125	27	3	MO/OCH-4948	1950
		36"	15"	49"	100	21	2	MO/OCH-4936	1580
	<i>Half-opened overhead cabinet with 2 hinged doors.</i>	78"	15"	49"	180	43	2	MO/OCE-4978	2680
		72"	15"	49"	165	40	2	MO/OCE-4972	2470
		60"	15"	49"	140	33	2	MO/OCE-4960	2190
		48"	15"	49"	120	27	2	MO/OCE-4948	1920
	<i>Half-opened overhead cabinet with 2 sliding doors.</i>	78"	15"	78"	265		2	MO/OCP-7878	3790
		72"	15"	78"	250		2	MO/OCP-7872	3670
		60"	15"	78"	225		2	MO/OCP-7860	3560
	<i>Wall mounted overhead cabinet with hinged doors.</i>	78"	15"	26"	190	43	4	MO/WCH-2678	1920
		72"	15"	26"	175	40	4	MO/WCH-2672	1780
		60"	15"	26"	150	33	4	MO/WCH-2660	1650
		48"	15"	26"	125	27	3	MO/WCH-2648	1410
		36"	15"	26"	100	21	2	MO/WCH-2636	1170
	<i>Wall mounted half-opened overhead cabinet with 2 hinged doors.</i>	78"	15"	26"	180	43	2	MO/WCE-2678	1780
		72"	15"	26"	165	40	2	MO/WCE-2672	1650
		60"	15"	26"	140	33	2	MO/WCE-2660	1510
		48"	15"	26"	120	27	2	MO/WCE-2648	1375
	<i>Wall mounted half-opened overhead cabinet with 2 sliding doors.</i>	78"	15"	26"	220	43	2	MO/WCP-2678	2340
		72"	15"	26"	205	40	2	MO/WCP-2672	2110
		60"	15"	26"	180	33	2	MO/WCP-2660	2010
		48"	15"	26"	160	27	2	MO/WCP-2648	1960

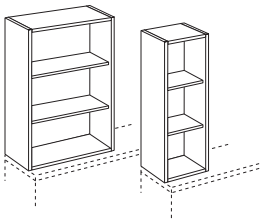
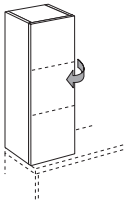
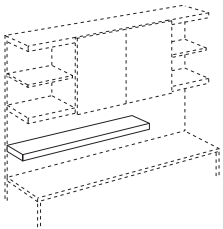

Les modules d'armoire peuvent être munis d'une serrure en option. Les dessus sont disponibles au pied linéaire (voir page 12).

An optional lock is available for the cabinets. Tops are available per linear foot (see page 12).

MODÈLE MODEL	DESCRIPTION DESCRIPTION	LARG. WIDTH	PROF. DEPTH	HAUT. HEIGHT	POIDS WEIGHT lbs -lbs	VOLUME VOLUME p ³ -ft ³	CODE CODE	PRIX PRICE
	Armoire ouverte. 2 tablettes réglables.	15"	15"	49"	40	10	MO/SO-15	1030
		30"	15"	49"	65	17	MO/SO-30	1170
		36"	15"	49"	80	21	MO/SO-36	1440
	<i>Open bookcase. 2 adjustable shelves.</i>							
	Module d'armoire gauche. 2 tablettes réglables. Pour armoire droite (MO/ SDR -15)	15"	15"	49"	45	10	MO/SDL-15	1235
	<i>Left closed end cabinet. 2 adjustable shelves. For right cabinet (MO/SDR-15)</i>							
	Tablette murale. Attaches murales incluses.	48"	8"	3"	25	3	MO/SHLF-W48	490
	<i>Open bookcase. Wall attachments included.</i>							

Les armoires peuvent être munies d'une serrure en option.
Les dessus sont disponibles au pied linéaire (voir page 12).

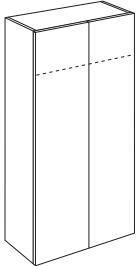
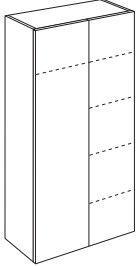

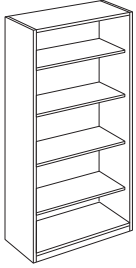
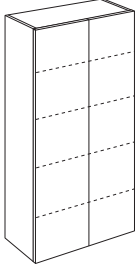
An optional lock is available for the closed bookcases. Tops are available per linear foot (see page 12).

MODÈLE MODEL	DESCRIPTION DESCRIPTION	LARG. WIDTH	PROF. DEPTH	HAUT. HEIGHT	POIDS WEIGHT lbs -lbs	VOLUME VOLUME p ³ -ft ³	CODE CODE	PRIX PRICE
	Penderie.	30"	20"	78"	250	30	MO/1-20	2190
	1 tablette fixe et barre à cintre.	36"	20"	78"	270	35	MO/1L-20	2330
<i>Wardrobe. 1 fixed shelf and coat rack.</i>								
	Armoire-penderie.	30"	20"	78"	260	30	MO/2-20	2470
	4 tablettes réglables, 1 tablette fixe et barre à cintre.	36"	20"	78"	280	35	MO/2L-20	2610
<i>Bookcase-wardrobe. 4 adjustable shelves, 1 fixed shelf and coat rack.</i>								
	Armoire ouverte	30"	14"	43"	75	13	MO/5-14	1150
	2 tablettes réglables.	30"	20"	43"	115	18	MO/5-20	1400
	Dessus inclus.	36"	14"	43"	100	15	MO/5L-14	1265
		36"	20"	43"	140	22	MO/5L-20	1540
<i>Open bookcase 2 adjustable shelves. Top included.</i>								
	Armoire ouverte	30"	14"	78"	160	21	MO/7-14	1510
	4 tablettes réglables.	30"	20"	78"	210	30	MO/7-20	1780
		36"	14"	78"	175	25	MO/7L-14	1650
		36"	20"	78"	225	35	MO/7L-20	1920
<i>Open bookcase 4 adjustable shelves.</i>								
	Armoire fermée..	30"	20"	78"	240	30	MO/8-20	2330
	4 tablettes réglables.	36"	20"	78"	255	35	MO/8L-20	2470
<i>Closed bookcase. 4 adjustable shelves.</i>								

Les armoires peuvent être munies d'une serrure en option.
Les dessus sont disponibles au pied linéaire (voir page 12).

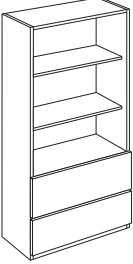
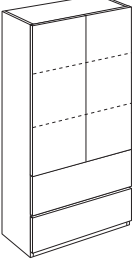
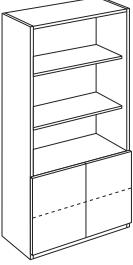
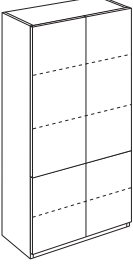
*An optional lock is available for the closed bookcases.
Tops are available per linear foot (see page 12).*

MODÈLE MODEL	DESCRIPTION DESCRIPTION	LARG. WIDTH	PROF. DEPTH	HAUT. HEIGHT	POIDS WEIGHT lbs -lbs	VOLUME VOLUME p ³ -ft ³	CODE CODE	PRIX PRICE
	Armoire ouverte-classeur latéral.	30"	20"	78"	250	30	MO/12-20	2920
	2 tablettes réglables et 2 tiroirs filières.	36"	20"	78"	270	35	MO/12L-20	3050
<p><i>Open bookcase-lateral file. 2 adjustable shelves and 2 filing drawers.</i></p>								
	Armoire fermée-classeur latéral.	30"	20"	78"	275	30	MO/13-20	3330
	2 tablettes réglables et 2 tiroirs filières.	36"	20"	78"	295	35	MO/13L-20	3470
<p><i>Closed bookcase-lateral file. 2 adjustable shelves and 2 filing drawers.</i></p>								
	Armoire ouverte-armoire fermée.	30"	20"	78"	240	30	MO/22-20	2330
	3 tablettes réglables.	36"	20"	78"	260	35	MO/22L-20	2470
<p><i>Open bookcase-closed bookcase. 3 adjustable shelves.</i></p>								
	Armoire fermée-armoire fermée.	30"	20"	78"	260	30	MO/23-20	2750
	3 tablettes réglables.	36"	20"	78"	280	35	MO/23L-20	2880
<p><i>Closed bookcase-closed bookcase. 3 adjustable shelves.</i></p>								

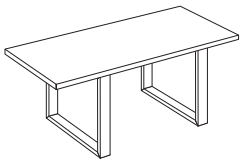
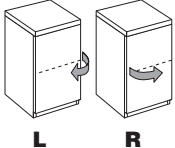
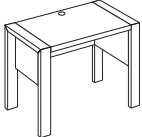
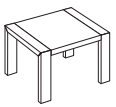
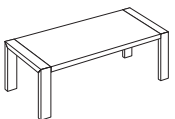
MODÈLE MODEL	DESCRIPTION DESCRIPTION	LARG. WIDTH	PROF. DEPTH	HAUT. HEIGHT	POIDS WEIGHT lbs -lbs	VOLUME VOLUME p ³ -ft ³	CODE CODE	PRIX PRICE	
	Table ronde avec base Moderno.	36" dia.		29"	100	14	MO/RTW-36	2280	
		42" dia.		29"	110	16		MO/RTW-42	2560
		48" dia.		29"	120	18		MO/RTW-48	2830
	<i>Round table with Moderno base.</i>								
	Table ronde avec base Moderno. Placage " Sunburst ".	36" dia.		29"	100	14	MO/RTW-36-S	2610	
		42" dia.		29"	110	16		MO/RTW-42-S	2890
		48" dia.		29"	120	18		MO/RTW-48-S	3160
	<i>Round table with Moderno base. "Sunburst" veneer.</i>								
	Table de conférence.	30"	72"	29"	155	42	MO/RE-7230	2270	
		36"	72"	29"	220	51		MO/RE-7236	2450
	<i>Conference table.</i>								
	Table de téléphone. 1 tablette réglable.	15 1/2"	20"	29"	60	9	MO/TSCL-1520	1150	
		15 1/2"	20"	29"	60	9		MO/TSCR-1520	1150
	<i>Telephone table. 1 adjustable shelf.</i>								
	Table d'imprimante.	36"	20"	29"	125	15	MO/VDT-3620	1700	
	<i>Printer table.</i>								
	-R Option roulettes -R Option casters	Ajoutez 120 \$ Add 120 \$							
	Table de bout.	24"	24"	20"	65	9	MO/OT-2424	1200	
		30"	30"	20"	75	10		MO/OT-3030	1350
	<i>End table.</i>								
	Table à café.	48"	24"	20"	90	17	MO/CT-4824	1560	
	<i>Coffee table.</i>								

L'unité tableau-marqueur est disponible en différents finis et peut être équipée de plusieurs options.

The markerboard unit is available in different finishes and can be supplied with several options.

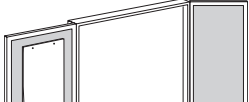
MODÈLE MODEL	DESCRIPTION DESCRIPTION	LARG. WIDTH	PROF. DEPTH	HAUT. HEIGHT	POIDS WEIGHT lbs -lbs	VOLUME VOLUME p ³ -ft ³	CODE CODE	PRIX PRICE
	Unité tableau-marqueur.	36"	4"	36"	75	4	MO/VB-RL-3636	1310
	Babillard en liège sur	48"	4"	48"	130	7	MO/VB-RL-4848	1630
	chaque porte et tableau	60"	4"	48"	150	9	MO/VB-RL-6048	2260
	magnétique.	72"	4"	48"	180	11	MO/VB-RL-7248	2550

Chants droits (**RL**).

*Markerboard unit.
Cork tackboard on each door
and magnetic markerboard.
Straight edges (**RL**).*



OPTIONS (Ajoutez au prix de liste - Add to list price)



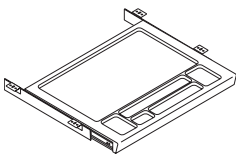
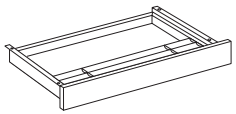
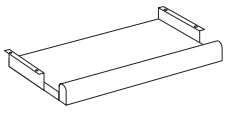
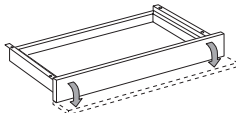
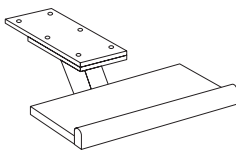

Écran de projection. <i>Projection screen.</i>	36"	36"	AC/PS-36	230
	48"	48"	AC/PS-48	275
	60"	48"	AC/PS-60	460
	72"	48"	AC/PS-72	495
Babillard en tissu. <i>Fabric tackboard.</i>	36"	36"	AC/FD-36	260
	48"	48"	AC/FD-48	310
	60"	48"	AC/FD-60	350
	72"	48"	AC/FD-72	420
Insertion dans les portes. <i>Doors inlay.</i>	36"	36"	AC/DI-36	230
	48"	48"	AC/DI-48	310
	60"	48"	AC/DI-60	350
	72"	48"	AC/DI-72	400
Serrure. <i>Lock.</i>			AC/LOCK	120
Bloc de conférence additionnel. <i>Additional flip chart.</i>			AC/FC	55
Coupe-papier. <i>Paper-cutter.</i>			AC/PC	55

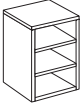
Chaque unité est équipée d'un tableau magnétique en porcelaine, l'intérieur des portes en liège, un bloc de conférence, un crayon indicateur, une efface, quatre marqueurs couleurs et un ensemble de fixations murales.

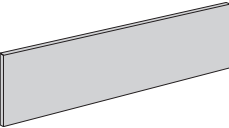
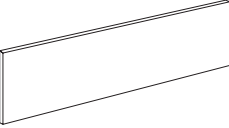
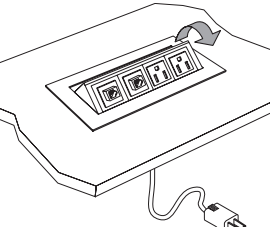
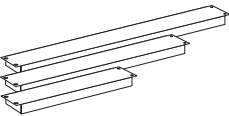
The markerboard unit is supplied with porcelain magnetic board, cork over doors, flip chart, pointer, eraser, four color markers and shipped with mounting brackets.

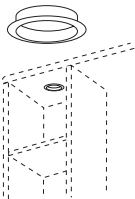
MODÈLE MODEL	DESCRIPTION DESCRIPTION	LARG. WIDTH	PROF. DEPTH	HAUT. HEIGHT	POIDS WEIGHT lbs -lbs	VOLUME VOLUME p ³ -ft ³	CODE CODE	PRIX PRICE
	Tiroir central compartimenté. <i>Molded center drawer.</i>	22"	18"	1 1/2"	10		AC/CD	360
	Tiroir central en bois avec plumier. <i>Wood center drawer with pencil tray.</i>	26"	22"	1 1/2"	10		AC/CDW	570
	Tablette coulissante pour clavier. Finis : noir (CS) bois (CSW) <i>Keyboard drawer.</i> <i>Finishes : black (CS)</i> <i>wood (CSW)</i>	23" 23-29"	11" 11"	3" 3"	10 11		AC/CS-22 AC/CS-28	220 360
		22" 28"	12" 12"	3" 3"	10 11		AC/CSW-22 AC/CSW-28	440 520
	Tiroir coulissant pour clavier. Finis : bois (CSDW) <i>Keyboard drawer.</i> <i>Finishes : wood (CSDW)</i>	30" 36"	16" 16"	3" 3"	15 17		AC/CSDW-30 AC/CSDW-36	640 770
	Tablette escamotable pour clavier. Bras articulé. Finis : noir (KAS) bois (KASW) <i>Retractable keyboard shelf.</i> <i>Articulated arm.</i> <i>Finishes : black (KAS)</i> <i>wood (KASW)</i>	23" 23-29"	11" 11"		20 21		AC/KAS-22 AC/KAS-28	400 630
		22" 28"	12" 12"		20 21		AC/KASW-22 AC/KASW-28	580 640

MODÈLE MODEL	DESCRIPTION DESCRIPTION	LARG. WIDTH	PROF. DEPTH	HAUT. HEIGHT	POIDS WEIGHT lbs -lbs	VOLUME VOLUME p ³ -ft ³	CODE CODE	PRIX PRICE
	<p>Trieur à papier avec 2 tablettes.</p> <p><i>Paper tray organizer with 2 shelves</i></p>	14"	11 1/2"	21 1/2"			AC/US-1420	580
	<p>Trieur à papier avec 1 tablette et 3 tiroirs de rangement.</p> <p><i>Paper tray organizer with 1 shelf and 3 storage drawers.</i></p>	14"	11 1/2"	21 1/2"			AC/UT-1420	980
	<p>Babillard pour huches "OCH et WCH". Prix pour tissu Grade 1 et C.O.M.</p> <p><i>Tackboard for "OCH and WCH" overhead cabinets. Price for Grade 1 and C.O.M. fabric.</i></p>	84" 78" 72" 60" 48" 36"	1" 1" 1" 1" 1" 1"	24" 24" 24" 24" 24" 24"			AC/TK-2484 AC/TK-2478 AC/TK-2472 AC/TK-2460 AC/TK-2448 AC/TK-2436	495 475 440 420 400 350
	<p>Panneau de bois arrière pour huches "WCH". Prix pour bois - grade 1.</p> <p><i>Wooden back panel for "WCH" overhead cabinets. Price for wood - Grade 1.</i></p>	84" 78" 72" 60" 48" 36"	1" 1" 1" 1" 1" 1"	24" 24" 24" 24" 24" 24"			AC/TW-2484 AC/TW-2478 AC/TW-2472 AC/TW-2460 AC/TW-2448 AC/TW-2436	650 580 520 460 330 260
	<p>Module de communication. Inclus 2 prises téléphone/réseau et 2 prises électriques. Fini aluminium. Fil de 6'.</p> <p><i>Power data center. Includes 2 voice/data ports and 2 simplexes. Aluminium finish. 6' power cord.</i></p>	8 1/4"	4 1/2"				AC/BYR	660
	<p>Lampe de travail. Fil de 8'. Tubes fluorescents inclus. Fini noir.</p> <p><i>Task light. 8' cord. Fluorescent tubes included. Black finish.</i></p>	25 1/2" 37 1/2" 49 1/2"	5 1/2" 5 1/2" 5 1/2"	2" 2" 2"	6 9 11		AC/L-24 AC/L-36 AC/L-48	330 430 520

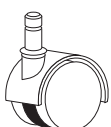
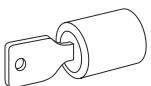
MODÈLE MODEL	DESCRIPTION DESCRIPTION	LARG. WIDTH	PROF. DEPTH	HAUT. HEIGHT	POIDS WEIGHT lbs -lbs	VOLUME VOLUME p ³ -ft ³	CODE CODE	PRIX PRICE
	Lampe DEL pour armoire. Fini noir (-B) ou métal brossé (-A) <i>LED light for bookcase. Black finish (-B) or brushed metal (-A)</i>	3" dia.					AC/LED	390
 LWC-1	Capuchon de filerie.	2 ³ / ₈ " dia.					AC/LWC-1	50
	Plastique noir.	3 ¹ / ₈ " dia.					AC/LWC-2	50
		6 ¹ / ₂ "	3"				AC/LWC-5	70
 LWC-2	<i>Grommet. Black plastic.</i>							
 LWC-5								
	Capuchon de filerie. Métal noir. <i>Grommet. Black metal.</i>	2 ³ / ₈ " dia.					AC/LWC-4	80
	Roulettes pour caissons. 4 roulettes avec frein. Fini noir. <i>Casters for pedestals. 4 casters with brake. Black finish.</i>	2" dia		2 ¹ / ₂ "			AC/CP	130
	Serrure. <i>Lock.</i>						AC/LOCK	80

Prix et termes

Les prix indiqués sont des prix de détail suggérés, F.A.B. notre usine, et sont sujets à changement sans préavis. Ils sont fermes et définitifs après l'acceptation de la commande. Les conditions : net 30 (trente) jours après la date de la facturation. Si les termes ne sont pas respectés, ceci engendrera une perte de cote de crédit et entraînera les frais de collection encourus. Artelite inc. se réserve le droit d'exiger un dépôt avec la commande ou avant la livraison de la marchandise.

Un dépôt de 50% est requis pour tout item non standard.

Note: Les dessins d'atelier prévalent toutes spécifications ou changements.

Commandes

Toute commande est sujette à l'approbation d'Artelite inc. et est considérée finale. Les confirmations de commande liant les parties confirment les prix, les termes et les dates de livraison anticipées.

Changements et annulations

Tout changement à une commande ou annulation doit être fait par écrit et est sujet à notre approbation. Artelite inc. se réserve le droit de facturer 25% pour la partie de commande déjà exécutée. Tout changement à une commande entraînant des modifications aux dessins retardera les délais de livraison. Les commandes de produits ou finis non-standard ne peuvent être annulées.

Entreposage

Des frais d'entreposage seront appliqués pour tout article non reçu par le client une semaine après la date prévue pour la livraison.

Expéditions

Les marchandises sont remises au transporteur en excellente condition. La responsabilité d'Artelite inc. cesse à partir de la prise en charge par le transporteur. Ce dernier sera choisi par Artelite inc. à moins d'indication contraire. Les réclamations pour commandes incomplètes ou marchandise endommagée doivent être présentées directement à la compagnie de transport et doivent être inscrites sur votre copie de connaissance.

Retour de marchandise

Toute marchandise retournée pour réparation ou crédit doit nous parvenir port payé et accompagnée d'un numéro d'autorisation de retour. Si cette procédure n'est pas suivie, la marchandise ne sera pas acceptée à l'usine et sera réexpédiée à vos frais sans autre formalité. Dans le cas d'un défaut de fabrication, la réclamation doit être faite dans les 10 (dix) jours, et la marchandise doit nous parvenir dans les 15 (quinze) jours suivant la réception du numéro d'autorisation de retour.

Entrée des commandes

Pour nous faciliter l'entrée de commandes et accélérer la livraison, assurez-vous d'avoir tous les détails suivants :

- numéro de modèle complet
- quantité
- description
- dimensions
- essence de bois / couleur / fini
- échantillon de couleur, si spéciale
- spécifications détaillées, si requises
- choix de tissus
- localisation de passe-fil
- étiquetage
- prix
- informations pour livraison et/ou installation

Les commandes de produits spéciaux doivent porter notre numéro de soumission ainsi que les dessins d'atelier approuvés.

Informations générales

Tous les produits d'Artelite inc. sont fabriqués avec des produits supérieurs, utilisant le placage de qualité architecturale. Artelite inc. se réserve le droit de modifier les designs, les matériaux, la construction ou les dimensions sans préavis. Les poids et les volumes indiqués sont approximatifs.

Spéciaux

Bien que nous ayons un éventail de produits variés, nous offrons aussi des spéciaux pour des contrats spécifiques. Notre département technique est à votre disposition pour vous aider à réaliser ces projets.

Finis

La plupart de nos produits sont disponibles dans 10 (dix) essences de bois et 21 (vingt-et-un) finis. Des finis spéciaux sont offerts moyennant un supplément. Les placages de bois utilisés peuvent présenter des différences naturelles de veinage ou teinte.

Garantie

Tous les produits manufacturés par Artelite inc. sont garantis contre tout vice de fabrication pour une période d'un an. La garantie structurelle est pour une période de 5 (cinq) ans.

Prices and terms

All prices shown are list prices, F.O.B. our factory, and are subject to changes without prior notice. They are firm and final after acceptance of the order. Terms are net 30 (thirty) days after invoicing date. Credit will be offered only to accredited buyers with good credit references. Failure to meet terms will result in loss of credit terms and collection cost of an attorney. Artelite inc. reserves the right to require a deposit with order or before shipment of the merchandise.

A 50% deposit is required for non-standard orders.

Orders

All orders are subject to acceptance by Artelite inc. and are considered final. Our order confirmations are formally acknowledged confirming prices terms and anticipated delivery date.

Changes and cancellations

Changes to orders or cancellations may be made in writing and are subject to acceptance by Artelite inc.. Artelite inc. reserves the right to charge 25% for the work in process or a restocking charge. Any product modifications resulting in certain changes to drawings may warrant scheduling delays. Orders of non-standard products or finish cannot be cancelled once released to manufacturing.

Storage

Orders that are produced and ready for shipment will be placed in storage at customer's expense, one week after the expected delivery date. Artelite inc. is not responsible for storage of products due to delays at the customer site which is out of our control.

Shipping

All furniture is shipped in excellent condition. Artelite's responsibility stops when the goods are accepted by the carrier. The carrier is chosen by Artelite unless otherwise stated. All claims concerning incomplete orders or damage must be presented directly to the carrier and clearly noted on the shipping bill of lading.

Returned goods

Goods returned for repair or credit must be shipped to us on a prepaid basis and accompanied by a return authorization number. If this procedure is not followed, the merchandise will not be accepted at factory and will be returned at your cost. All claims concerning workmanship or defects must be done within 15 (fifteen) days following receipt of the return authorization number.

Order entry

To assist in processing your order, be assured that all information required is included on your purchase order:

- complete model number
- quantity per item
- description of item
- dimensions
- wood species / color / finish
- special color sample, if required
- detailed specifications, if required
- fabric selection
- grommet location
- tagging information
- price
- shipping and/or installation information

Special orders must include our special quotation number and approved engineering drawings.

General informations

Artelite inc. products are constructed of superior materials using architectural grade veneers. Artelite reserves the right to make any changes in product design, materials, construction or dimensions of its products without prior notice. Weight and measures are approximate.

Specials

Although our product offering is comprehensive, special items and custom-made contracts are available. We provide a complete engineering service to assist in securing these special projects.

Finishes

Most of our products are available in 10 (ten) wood species and 21 (twenty-one) finishes. Special custom blended wood finishes are available on request, at extra charge. It should be noted that a difference can occur due to the variation in tone and color of select figured woods and veneers.

Warranty

All Artelite products are guaranteed for a period of one full year against defective materials and workmanship. A five year structural warranty applies to all Artelite inc. products.

20
ans • years



10251, boul Ray-Lawson, Montréal (Québec) Canada H1J 1L6
514 493 6113 1 800 737 5137 Fax 514 493 3422
info@artelite.com ▲ www.artelite.com